

Article number: 4395000401

Description: Rota-fix shaft-hub connection F40x75  
Stainless steel

## Measures

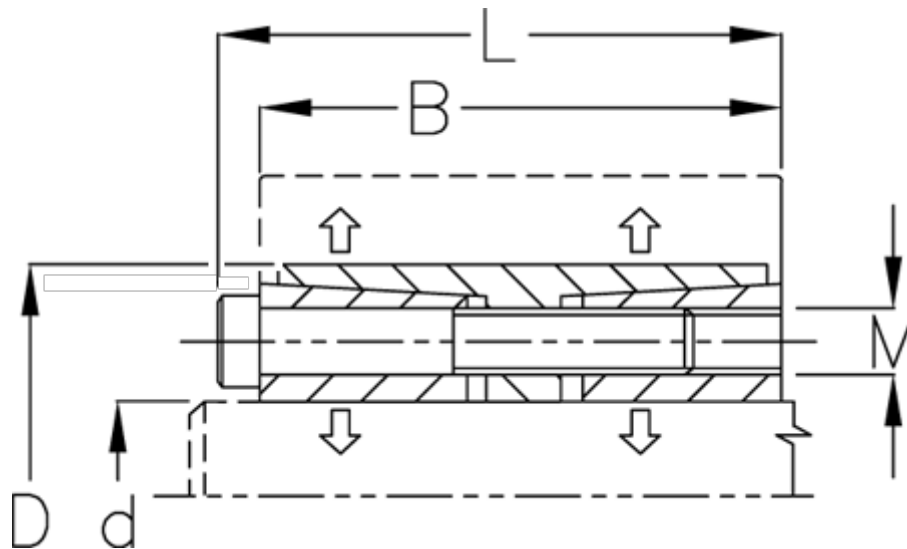

B mm	= 54
d H8 mm	= 40
D mm	= 75
Fit tolerance	= Aksel h8, Nav H8
F kN torque	= 76.7
L mm	= 62
M mm	= M8
P N/mm <sup>2</sup> surface pressure on shaft/hub	= 38

Surface roughness	= R ? ? 3.2 $\mu$ m
T N m torque	= 1530
Ts N m bolt tightening torque	= 28.7